

ILLUSTRATED GUIDE

Energy Efficiency Requirements for Houses in British Columbia

Climate Zones 5 to 7A
North Vancouver Island
and Interior

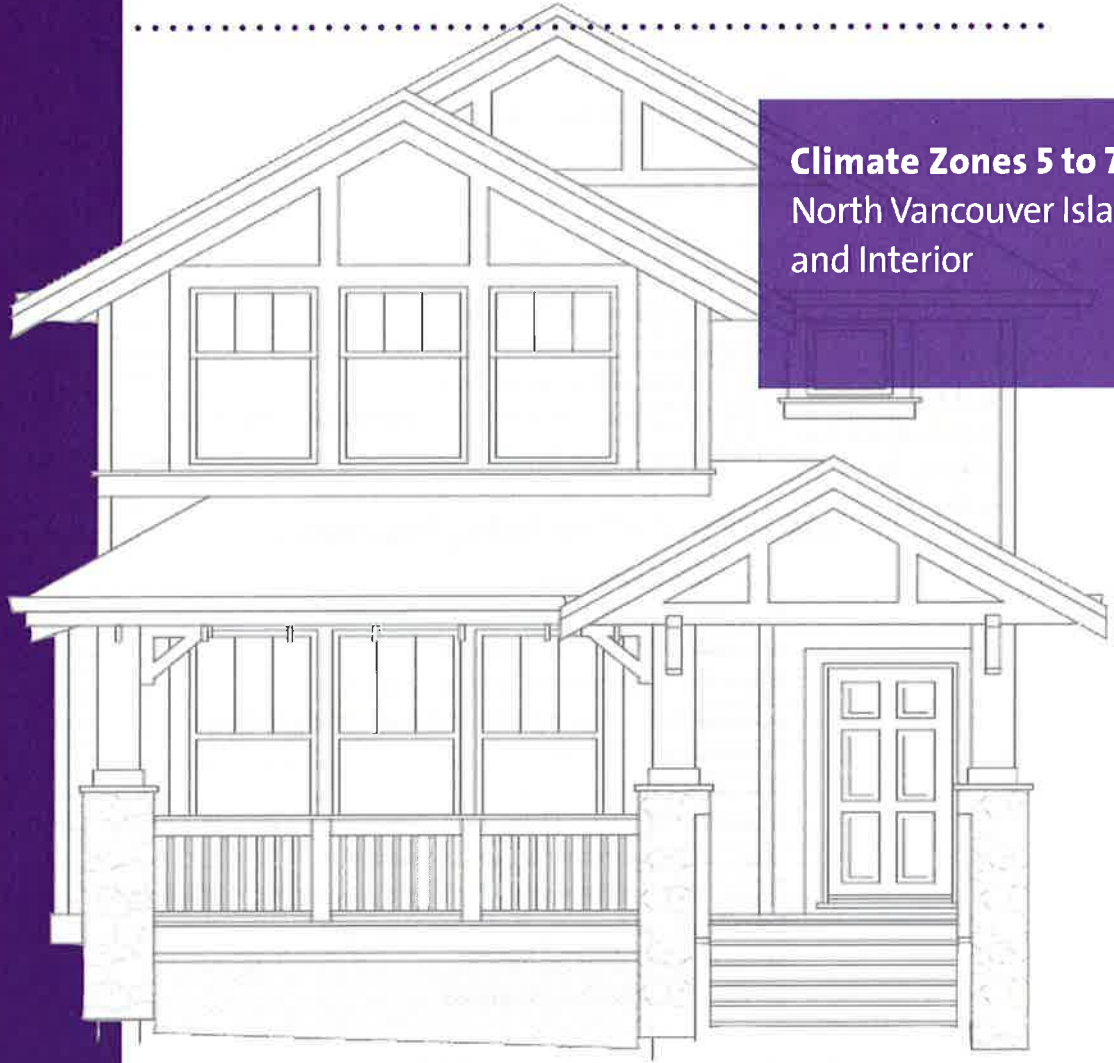

This guide has been developed to assist builders and residential industry stakeholders in understanding and complying with the new requirements in Section 9.36. of the British Columbia Building Code.



Homeowner
Protection Office
Branch of BC Housing

Table of Contents

Forward	3
Changes to Provincial Energy Efficiency Requirements	3
Other Useful Information	3
Acknowledgements.....	3
Disclaimer	3
General	4
Scope	4
Compliance and Application	4
Building Envelope	6
Continuity of Insulation.....	6
Thermal Characteristics of Building Assemblies.....	9
Windows, Doors and Skylights	12
Airtightness	12
Construction of Air Barrier Details.....	12
Trade-off Options for Above-ground Building Envelope Components and Assemblies.....	17
HVAC and Service Water Heating Requirements	18
Scope and Application.....	18
Equipment and Ducts.....	18
Air Intake and Outlet Dampers.....	18
Piping for Heating and Cooling Systems	19
Equipment for Heating and Air Conditioning Systems.....	19
Temperature Controls.....	19
Humidification	19
Heat Recovery from Dehumidification in Spaces with an Indoor Pool or Hot Tub	20
Heat Recovery from Ventilation Systems.....	20
Space Heat and Service Water Heating Equipment Efficiency.....	20
Solar Thermal Systems for Space Heat and Service Water Heating	20
Service Water Heating Piping	20
Service Water Heating Controls	20
Appendix 1: Section 9.36. Checklist	22

Forward

This guide has been developed to assist residential builders and industry stakeholders in British Columbia to interpret and comply with changes to the 2012 British Columbia Building Code (“the Code”) for energy efficiency for housing and small buildings. It is one in a series of guides designed to provide information for specific climate zones in British Columbia.

Changes to Provincial Energy Efficiency Requirements

Commencing December 19, 2014, applications for building permits must comply with new requirements for energy efficiency in housing, small commercial and industrial buildings. The new building envelope requirements vary depending on your location. New Code requirements are also being added related to the energy efficiency of heating, ventilation and air conditioning (HVAC) equipment and service water heating (SWH).

Other Useful Information

A number of documents complement this guide and are recommended reading to assist builders in the design and construction of homes, including:

- Homeowner Protection Office (HPO)¹, *Building Envelope Guide for Houses*.
- Canadian Home Builders’ Association, *Builders’ Manual*².

Acknowledgements

The publication was developed through extensive consultation with many individuals and organizations involved in residential construction in British Columbia. The HPO gratefully acknowledges the valued contributions made by the project industry committee, including residential builders, building officials, energy advisors, warranty providers and the Building and Safety Standards Branch. This guide was prepared by Innes Hood Consulting Inc. in collaboration with RDH Building Engineering Limited. Special thanks to Innes Hood, James Higgins and Graham Finch for their work on this project.

Disclaimer

This guide is intended to provide readers with general information about aspects of Part 9 of the British Columbia Building Code. Readers are urged not to rely simply on this guide, but to carefully review the Code and consult with appropriate and reputable professionals and construction specialists to assist in interpreting and applying the Code. It is the responsibility of all persons undertaking the design and construction of a house to fully comply with the requirements of the Code. The authors, contributors, funders and publishers assume no liability for the accuracy of the statements made or for any damage, loss, injury or expense that may be incurred or suffered as a result of the use of or reliance on the contents of this guide. The views expressed do not necessarily represent those of individual contributors or the Homeowner Protection Office, a branch of BC Housing, or the Building and Safety Standards Branch.

¹ <http://www.hpo.bc.ca/publications>

² www.chba.ca/buildermanual.aspx

General (9.36.1.)

This guide has been developed at the request of the Building and Safety Standards Branch to assist residential builders and industry stakeholders. It focuses on the most commonly used assemblies that will meet the requirements of the Code and provide durable service.

Specifically, this guide:

1. provides residential builders with information to assist in the interpretation of the minimum requirements of the relevant energy efficiency requirements in the Code (Section 9.36.), and
2. highlights how the new Code requirements differ from existing requirements for energy efficiency.

Scope (9.36.1.1.)

The scope of this guide is limited to single family houses. While Section 9.36. does include other small residential, commercial and industrial buildings, they are not addressed in this document.

Compliance and Application (9.36.1.3.)

Buildings must comply with the prescriptive requirements of Subsections 9.36.2. through 9.36.4. Alternatively, buildings can be built to meet the performance compliance path requirements described in Subsection 9.36.5. of the Code, however, the performance path is not discussed in this document.

Section 9.36. has six climate zones (*Figure 1*). The specific weather location may be determined by referencing the local authority or Appendix C of Division B in the Code. This particular guide provides information specific to Climate Zones 5 through 7A.

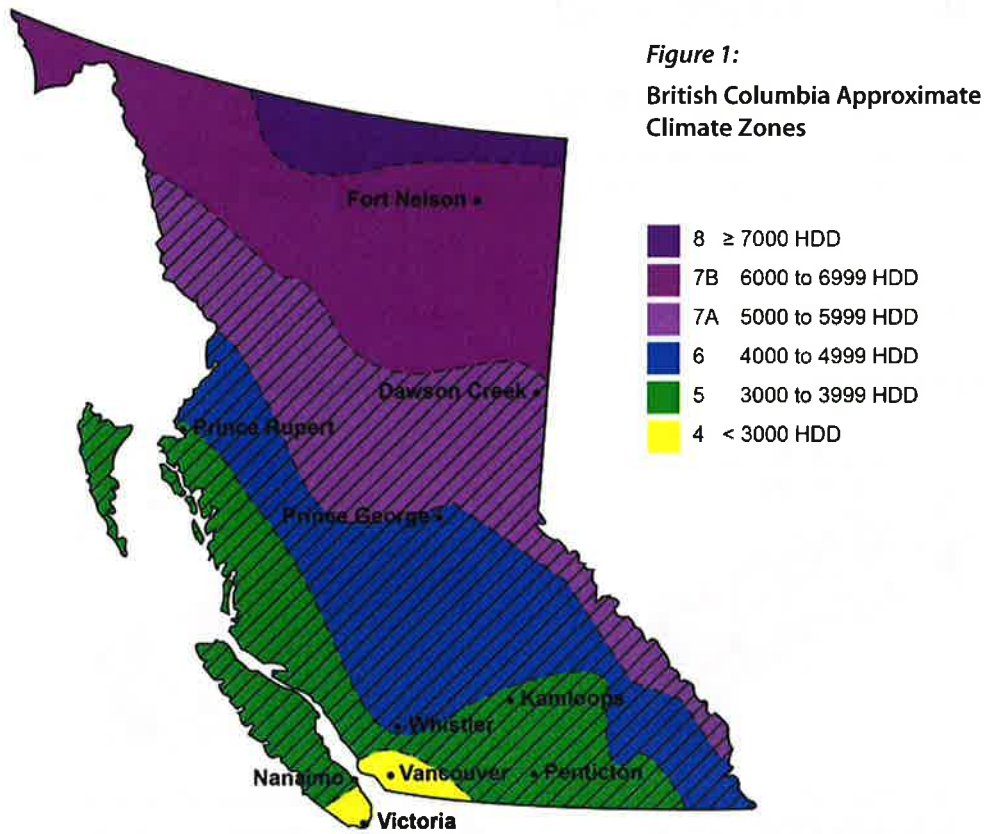

Urban centres in Climate Zones 5 to 7A include:

Climate Zone 5

- Ashcroft
- Bamfield
- Bella Bella
- Bella Coola
- Burnaby
- Cache Creek
- Campbell River
- Castlegar
- Comox
- Courtenay
- Crescent Valley
- Gold River
- Grand Forks
- Hope
- Kamloops
- Kaslo
- Kelowna
- Kitimat
- Ladysmith
- Port Alberni
- Queen Charlotte City
- Salmon Arm
- Sandspit
- Tahsis
- Tofino
- Trail
- Ucluelet
- Vernon
- Youbou

Climate Zone 6

- Carmi
- Cranbrook
- Dog Creek
- Elko
- Fernie
- Golden
- Greenwood
- Kimberley
- McBride
- Prince George
- Princeton
- Quesnel
- Revelstoke
- Stewart
- Terrace
- Whistler
- Williams Lake

Climate Zone 7A

- 100 Mile House
- Burns Lake
- Chetwynd
- Dawson Creek
- Fort St. John
- Glacier
- Mackenzie
- McLeod Lake
- Smithers
- Taylor

.....
Always check with your local building official to confirm the climate zone.

Building Envelope (9.36.2.)

Continuity of Insulation (9.36.2.5.)

The continuity of the effectiveness of insulation is required. This may not require continuous insulation, since the Code permits interruptions from framing and other penetrations.

Important Code Change:

Thermal insulation requirements are now defined in terms of *effective* insulation. Previous versions of the Code referenced *nominal* insulation.

RSI and R-value Conversion

"R-value" =
 $5.678 \times \text{RSI}$

Important Code Change:

Attached garages are treated as unconditioned space, even if the garage is insulated and intended to be heated. The assembly separating the garage from the house must be insulated and be made airtight.

Insulation Terminology

Nominal Insulation

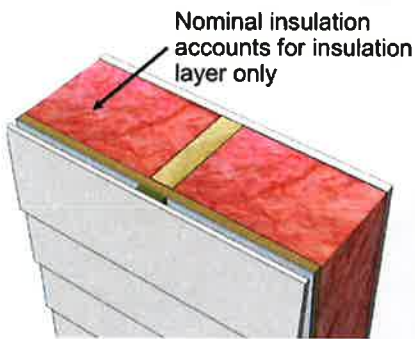

Nominal insulation accounts only for thermal resistance of the insulation.

Effective Insulation

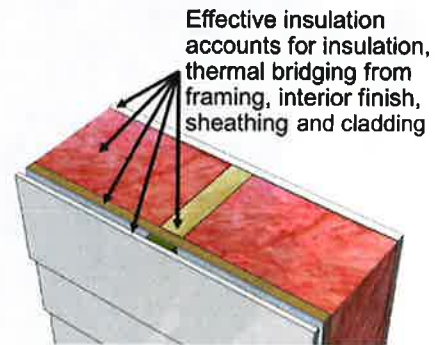

Effective insulation takes into account all assembly components, including framing, sheathing, cladding etc.

Continuity of Effective Insulation

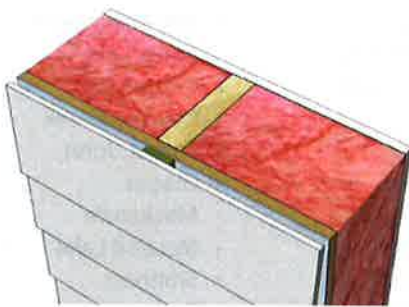

Insulation in the framing cavity achieves continuity of effective insulation.

Continuous Insulation



Continuous insulation achieves continuity but is not required.

Typical locations requiring attention to detailing to provide for continuity of insulation are presented in *Figure 2*. A checklist providing frequent locations of thermal losses and air leakage is included in the appendix.

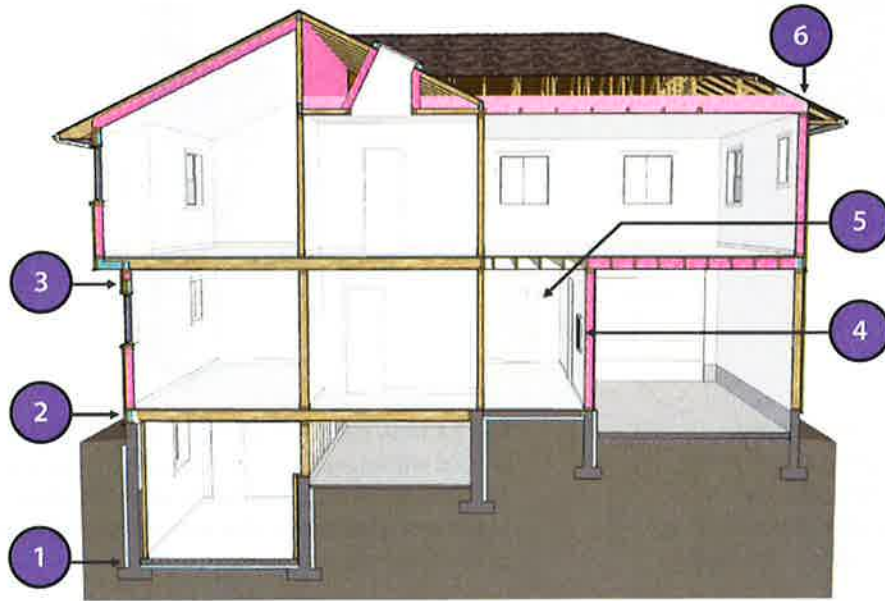

Figure 2:
Typical Problem
Areas for Insulation
Continuity

Insulation Continuity Details

Foundation Wall



Insulation separated by the foundation wall at the floor slab is not required to be continuous, provided the exterior insulation extends down to the footing.

Two Planes of Insulation

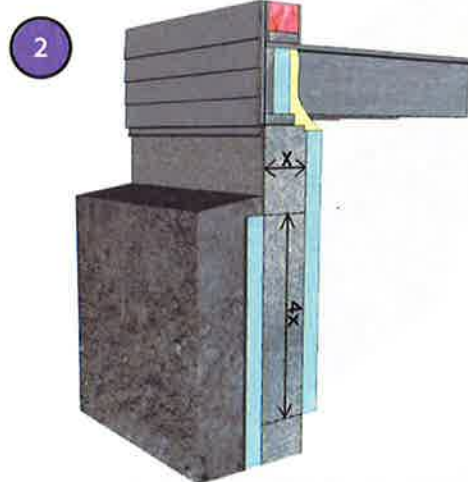

Where two planes of insulation are separated by a building envelope assembly and cannot be physically joined, one of the planes of insulation must be extended to overlap four times the thickness of the separation.

Headers and Rim Joists

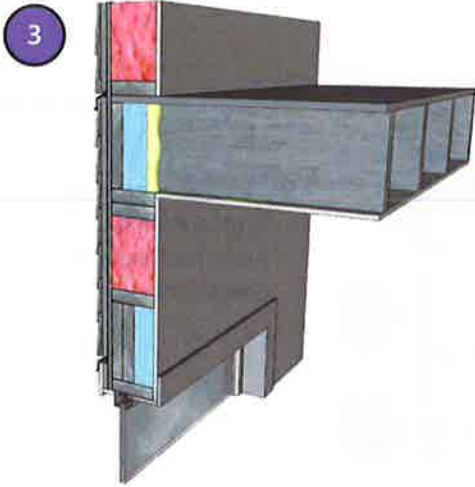

The thermal bridging effect of closely spaced, repetitive structural members like studs and joists, and of ancillary members like lintels, sills and plates, must be accounted for when calculating the thermal resistance of building envelope assemblies.

Electrical Panel

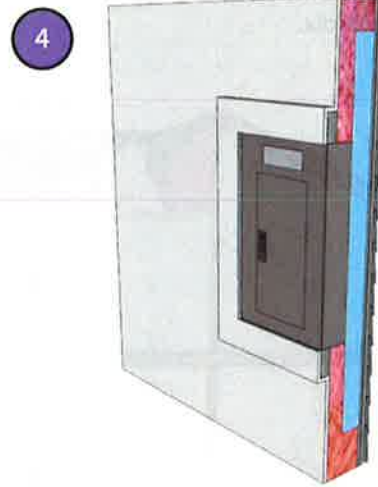

Mechanical, electrical and plumbing components placed within and parallel to an exterior wall are required to be insulated to the effective thermal resistance required for the wall at the projected area of the system component.

Wall to Window or Door Interface



Joints and junctions between walls and other components like windows and doors need to have the same effective R-value as the lower of the adjoining components. For windows and doors, additional insulation at the rough opening is typically not required.

Attic Insulation at Outside Walls



A reduction in the thermal resistance of the attic insulation at the perimeter is permitted, provided the insulation is constrained only by the roof slope and venting requirements, and the minimum thermal resistance value above the exterior wall is at least RSI 3.52 (R-20).

Thermal Characteristics of Building Assemblies (9.36.2.6. - 9.36.2.8.)

Typical *nominal* insulation values to achieve the *effective* requirements³ of Section 9.36. are shown in **Table 1**.

Table 1: Nominal Insulation Levels by Assembly to Achieve Effective Insulation Requirements

Assembly	Nominal Insulation (With or Without HRV)
Attic Ceiling (Typical Truss at 24" o.c.)	Zone 5 & 6: R-50 (RSI 8.8)
	Zone 7A: R-60 (RSI 10.6)
Cathedral Ceiling	Zone 5 & 6: R-28 (RSI 4.9) – 2x10, 16" o.c.
	Zone 7A: R-31 (RSI 5.5) – 2x12, 16" o.c.
Wall (2x6" at 16" o.c.)	Cavity R-24 (RSI 4.2)
	Continuous exterior wall insulation not required
Floor over Unheated Space	Zone 5 & 6: R-28 (RSI 4.9) – 2x10, 16" o.c.
	Zone 7A: R-31 (RSI 5.5) – 2x12, 16" o.c.

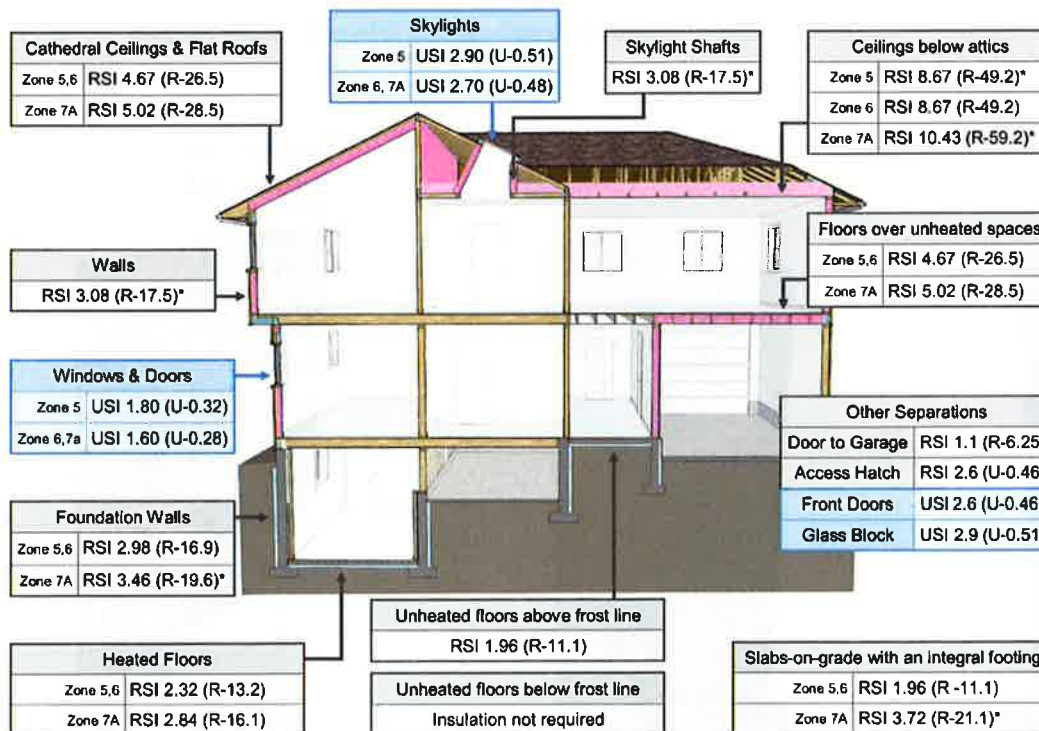

Figure 3:
Effective Insulation Requirements

* denotes where insulation adjustments are permitted with addition of an HRV.

³ The Canadian Wood Council has an online tool to assist in calculation of the effective thermal resistance of wall assemblies, located at www.cwc.ca/wtd

Commonly Accepted Above Grade and Below Grade Assemblies

Below Grade Wall Assembly for Zones 5 and 6

Description	Nominal	Effective
3" XPS insulation over 8" poured-in-place concrete wall	RSI 2.64 (R-15)	RSI 2.65 (R-15.3)
Other building enclosure layers that contribute to effective insulation: 1. dampproofing 2. interior air film	-	RSI 0.33 (R-1.9)
Total effective insulation value:		RSI 2.98 (R-16.9)
Minimum effective thermal resistance for below grade walls:		RSI 2.98 (R-16.9)

Above Grade Wall Assembly

Description	Nominal	Effective
R-24 batt insulation in 2x6 wood framing at 16" o.c.	RSI 4.2 (R-24)	RSI 2.66 (R-15.1)
Other building enclosure layers that contribute to effective insulation:*		
1. exterior air film	0.03	
2. cladding & air cavity	0.18	
3. sheathing membrane	-	RSI 0.52 (R-2.95)
4. sheathing	0.11	
5. polyethylene	-	
6. gypsum board	0.08	
7. interior air film	0.12	
Total effective insulation value:		RSI 3.18 (R-18.1)
Minimum effective thermal resistance for above grade walls:		RSI 3.08 (R-17.5)

*Varies by wall assembly. To be confirmed by designer.

Basement Wall with Exterior Insulation



Basement Wall with Interior Insulation



Above Grade Framed Wall



Permitted placement of insulation for unheated floors and slab on grade assemblies is shown below.

Insulation of Unheated and Heated Slabs above the Frost Line

Insulation Placement of Unheated Slabs

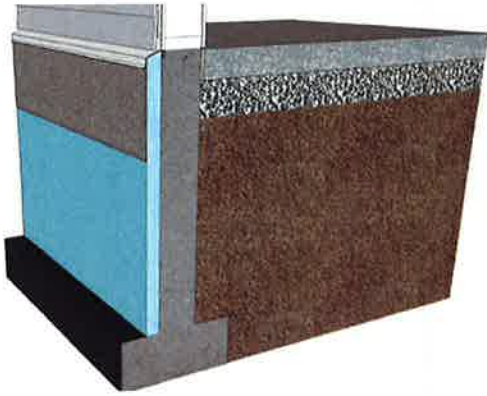

Slab on grade at foundation wall with exterior insulation to the footing.

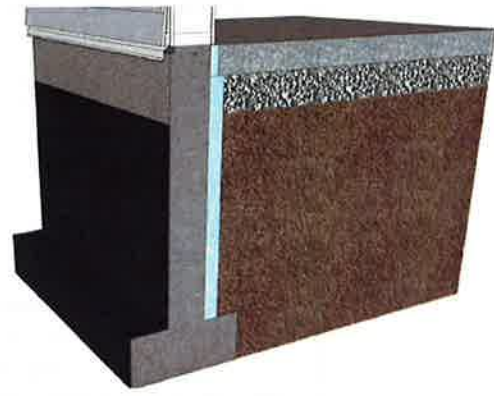

Slab on grade at foundation wall with interior insulation down 1.2 m, or to the footing with a thermal break at the slab.

Insulation Placement for Heated Slabs



Exterior insulation to the footing and insulation under all heated slab areas.



Interior wall insulation and insulation under all heated slab areas.

Windows, Doors and Skylights (9.36.2.7.)

All window, door and skylight assemblies have labeling requirements. A sample label presenting the U-value requirements for a window is presented in *Figure 4*.

ENERGY PERFORMANCE RATINGS		
U-Factor	Solar Heat Gain Coefficient	Visual Transmittance
1.60 <small>W/m²-K</small>	0.19	0.35
17	12	
BC's Best Window Company A100 Series Casement window Vinyl frame, Double glazed, Low-E coating Argon fill		
Certification Agency Logo	Energy performance ratings certified to CSA A440.2-09. Ratings are determined for a fixed set of environmental conditions and a specific reference product size. Certification agency does not recommend or warrant product for any specific use.	

Figure 4: Example Window Label showing U-value

Airtightness (9.36.2.9.)

A continuous air barrier is required. Article 9.36.2.9. requires that the air barrier be continuous:

- across joints,
- between assemblies, and
- around penetrations.

Further requirements for air barriers are defined in Subsection 9.25.3. of the Code.

Construction of Air Barrier Details (9.36.2.10.)

The Code has identified a number of details that have been shown to be problematic for air sealing. The locations are highlighted in *Figure 5*.

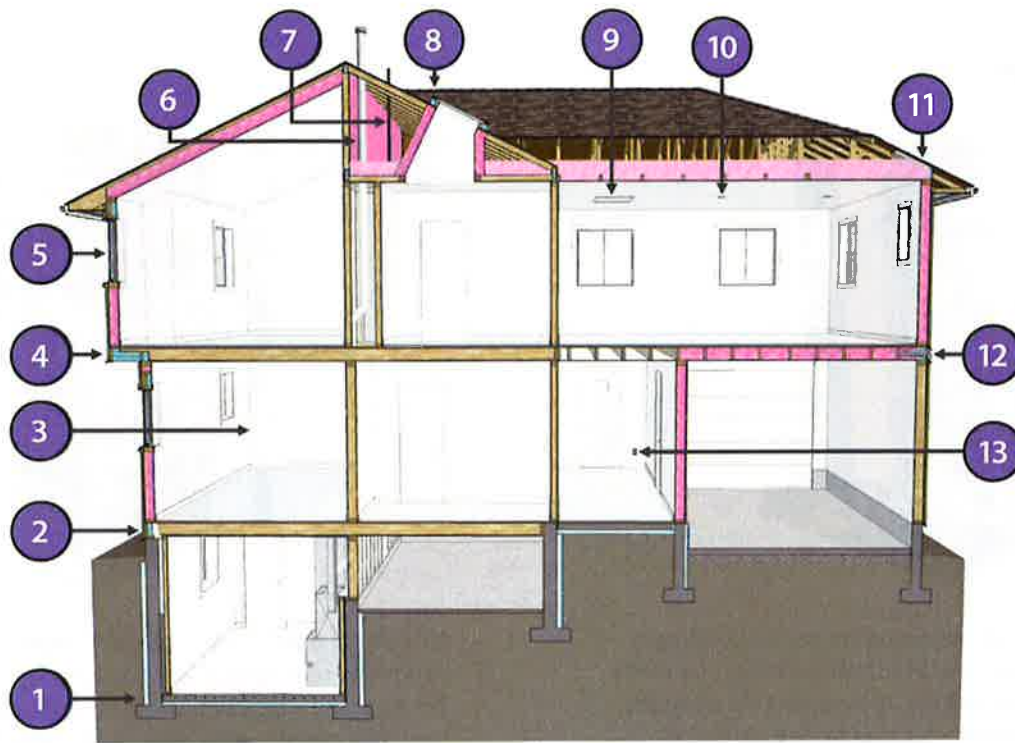
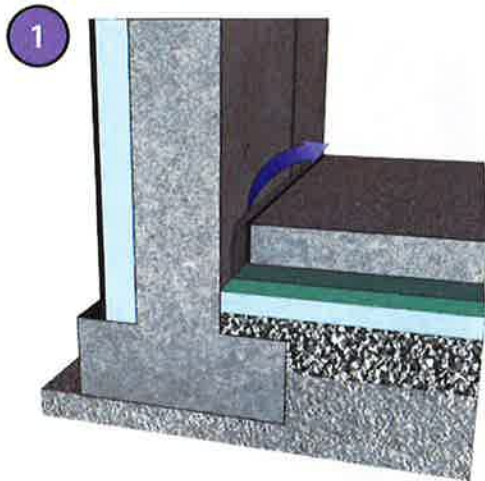

Figure 5: Air Barrier Detail Locations

Leakage Paths in Problematic Air Barrier Details

Slab Foundation Wall



The floor slab air barrier must be made airtight by sealing the floor slab to the foundation wall.

Foundation to Sill Plate and Rim Joists

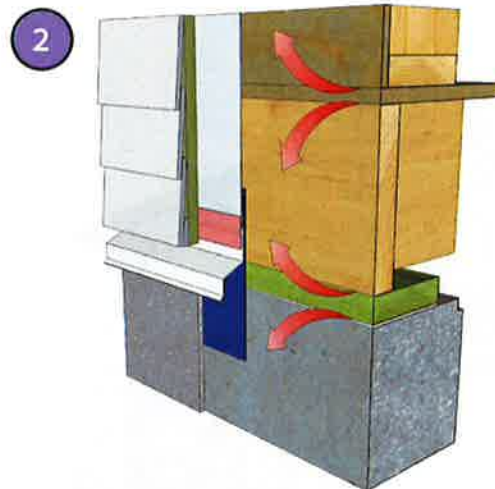

All joints at the transition between the foundation wall and the above grade wall must be made airtight by sealing all joints and junctions between the structural components, or covering the structural components with an air barrier material.

Interior Wall Interface



Interior walls that meet exterior walls or ceilings with an interior plane of airtightness must be made airtight by either sealing all junctions between the structural components, covering the structural components with an air barrier material and sealing it to the adjacent air barrier material, or maintaining the continuity of the air barrier system through the interior wall.

Rim Joist



All joints at the rim joist assembly must be made airtight by sealing all joints and junctions between the structural components, or covering the structural components with an air barrier material.

Cantilevered Floor

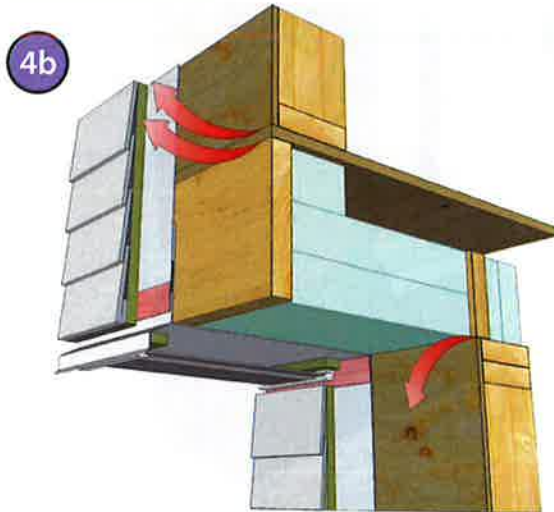

Cantilevered floors and floors over unheated spaces/ exterior space must be made airtight by sealing all joints and junctions between the structural components, and/or covering the structural components with an air barrier material and sealing it to the adjacent air barrier material.

Window Head



The interface between window head/jamb and wall assembly must be made airtight by sealing all joints and junctions between the air barrier material in the wall and the window. The requirement also applies to doors and skylights.

Window Sill



The interface between window sill and wall assembly must be made airtight by sealing all joints and junctions between the air barrier material in the wall and the window. The requirement also applies to doors and skylights.

Mechanical Flues and Chimneys

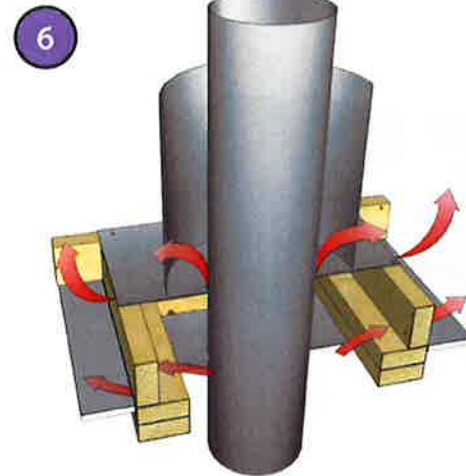

Steel-lined chimneys that penetrate the building envelope must be made airtight by blocking the void between required clearances for metal chimneys and surrounding construction with sheet metal and sealant capable of withstanding high temperatures.

Plumbing Stacks

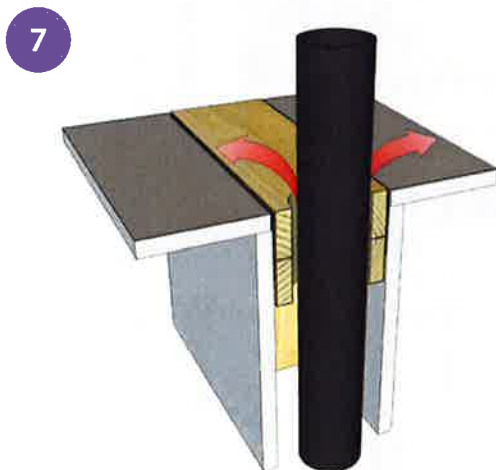

Plumbing vent stack pipes that penetrate the building envelope must be made airtight by either sealing the air barrier material to the vent stack pipe with a compatible material or sheathing tape, or installing a rubber gasket or prefabricated roof flashing at the penetration of the plane of airtightness and sealing it to the top plate.

Skylights

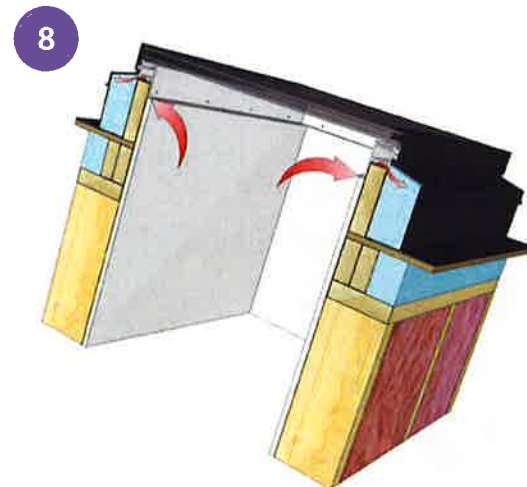

The interface between the skylight and wall assembly must be made airtight by sealing all joints and junctions between the air barrier material in the wall and the skylight.

Attic Hatches

9

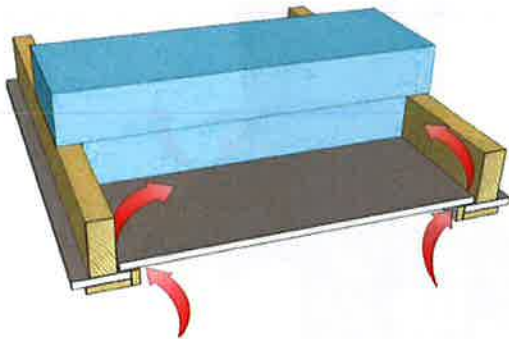

Air leakage occurs through the joint between the hatch and the ceiling. The hatch is most often a piece of gypsum board cut to size resting on a ledge made from wood trim or the edge of the ceiling. Air sealing can be achieved by ensuring the hatch is sized properly so that it has enough contact with the opening ledge and providing a closed cell foam gasket.

Pot Lights

10

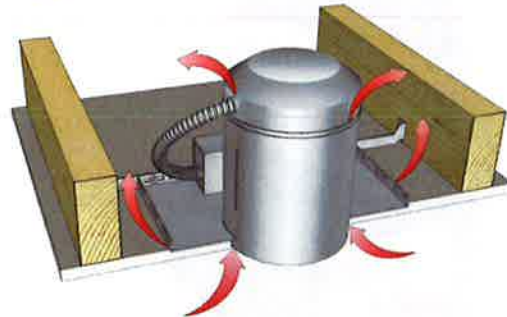

Recessed pot light housings are one of the most common air leakage points through the ceiling plane into the attic. Air leakage occurs between the housing and air barrier through the fixture housing holes and its electrical connections. Installing boxes around the pot lights which are sealed to the air barrier is an effective way to deal with this issue.

Wall to Ceiling

11

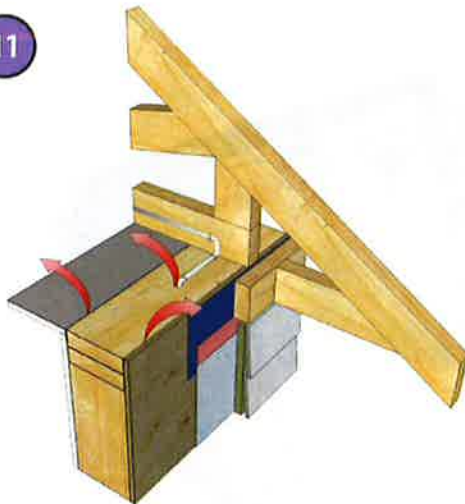

All joints at the transition between the above grade wall and ceiling must be made airtight by sealing all joints and junctions between the structural components and/or covering the structural components with an air barrier material.

Wall Vented Ducts

12

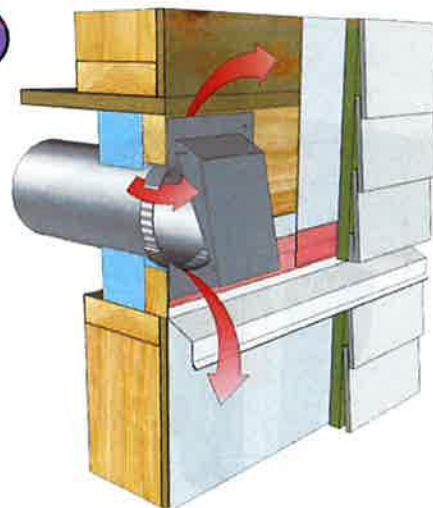

Duct penetrations through the building envelope must have an airtight seal.

Electrical Penetrations in Walls

13



Electrical penetrations in walls, including electrical outlets, wiring, switches and recessed light fixtures through the plane of airtightness must be airtight. Options include using a component that is designed to be airtight and sealing it to the adjacent air barrier material, or by covering the component with an air barrier material and sealing it to the adjacent air barrier material.

Trade-off Options for Above-ground Building Envelope Components and Assemblies (9.36.2.11.)

Article 9.36.2.11. is not mandatory. It is intended to permit minor trade-offs of building envelope components to allow for the reduction in the thermal performance of one assembly, while compensating with increased performance of the assembly in a different location. An example is the installation of a small heritage window on one wall and compensated by improved performance of other windows on the same wall.

Trade-offs are permitted with:

- above grade walls, floors and roofs
- between windows that are located on the same wall.

There are a number of restrictions, for example:

- trade-offs have limits on how much reduction can take place
- cannot trade off walls for windows (or vice versa).

Reference to the Code is recommended to determine the allowable trade-offs.

HVAC and Service Water Heating Requirements

(9.36.3. & 9.36.4.)

While HVAC and service water heating requirements are in different parts of Section 9.36., they have been combined in this guide for simplicity.

Scope and Application (9.36.3.1. & 9.36.4.1.)

This section applies to the efficiency of heating ventilation and air conditioning equipment and service water heating. The design and installation of HVAC and service water heating systems are covered in Sections 9.32. and 9.33. of the Code.

Equipment and Ducts (9.36.3.2.)

HVAC systems and ducts are required to be sized in accordance with “good practice,” such as described in the Thermal Environmental Comfort Association (TECA) reference material, CSA 280, and Sections 9.32. and 9.33. In addition, 9.36. requires that:

- transverse and longitudinal joints in duct work must be sealed using an approved tape and sealant when outside the plane of insulation
- ducts must be insulated to the same level as required for walls if they are outside of the envelope and carrying conditioned air (*Figure 6*).

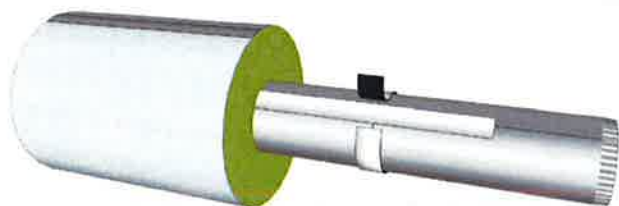

Figure 6:
Sealing and Insulation
Requirements for Ducts Outside
Plane of Insulation

Air Intake and Outlet Dampers (9.36.3.3.)

In general, ducts are required to be equipped with a damper. The damper may be gravity operated, motorized or spring loaded. Where motorized dampers are used, they must remain in an open position if damper operation fails, such as during power outages. Examples of requirements are summarized below (*Table 2*).

Table 2: Requirements for Dampers

Location	Damper Required?
Flue connected to water heater	Not required
Condensing furnace/boiler air intake/exhaust	Not required
Combustion air intake on fireplace or woodstove	Not required
Ventilation air intake	Required
Clothes dryer vent	Required
Combined supply and exhaust ventilators	Required
Exhaust and supply fans	Required

Piping for Heating and Cooling Systems (9.36.3.3.)

Pipe materials, insulation and coverings are addressed in Subsection 9.33.8. of the Code. To reduce thermal losses from piping systems, piping from heating and cooling equipment must be located inside the plane of insulation. Where piping is installed outside the plane of insulation, additional insulation is required to achieve a thermal resistance equivalent to exterior above grade wall requirements defined in 9.36.2. (Figure 7).

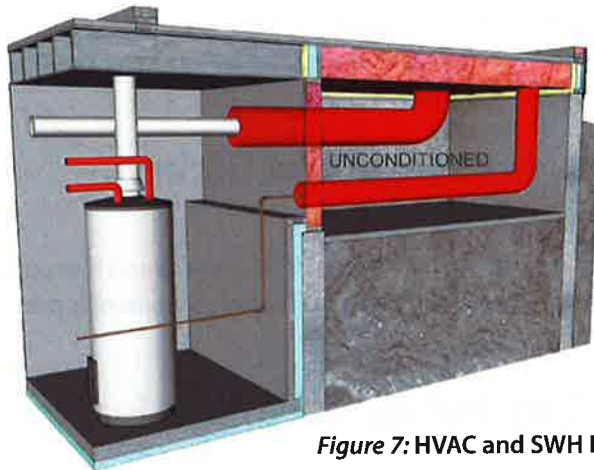

Figure 7: HVAC and SWH Insulation Requirements

Equipment for Heating and Air Conditioning Systems

Important Code Change: HVAC equipment must be located inside the plane of insulation. Only HVAC equipment designed strictly for outdoor installation can be located outside the conditioned space. Attached garages, even if heated, are considered unconditioned space.

Temperature Controls (9.36.3.6.)

Temperature controls are generally required for heating and cooling equipment. The accuracy of the control must be better than plus or minus 0.5°C. Solid fuel fired appliances, such as wood heaters and stoves, are exempt from this requirement.

Further requirements are provided for installations that have both heating and cooling equipment to prevent operation of heating and cooling equipment at the same time. In dwelling units with multiple zones, controls are required to permit adjustment of individual thermal zones.

Humidification (9.36.3.7.)

Humidification is not a requirement of Section 9.36. However, when humidification is provided, the equipment must come with an automatic humidity control device.

Good Practice Tip:

Venting of Combustion Equipment

While sidewall venting of tankless hot water heaters and furnaces is permitted, venting through the roof is generally recommended in order to avoid condensation and moisture build up issues that have been found to occur in sidewall venting installations.

Heat Recovery from Dehumidification in Spaces with an Indoor Pool or Hot Tub (9.36.3.8.)

Installation of a heat recovery ventilation system or dehumidification is required unless the total water surface area is less than 10 m² (108 ft²) and the pool or hot tub is equipped with a cover having a nominal thermal resistance greater than or equal to RSI 2.1 (R-12).

Heat Recovery from Ventilation Systems (9.36.3.9.)

Heat recovery ventilation is not a requirement of Section 9.36. Where heat recovery ventilators⁴ are used, equipment must conform to the requirements of 9.36.3.9., including having a minimum sensible heat recovery efficiency of 60%.

Space Heat and Service Water Heating Equipment Efficiency (9.36.3.10.) & (9.36.4.2.)

Equipment efficiency requirements are defined for a range of equipment and fuel options in Table 9.36.3.10. of the Code. A summary of requirements for typical equipment is presented in **Table 3**.

Solar Thermal Systems for Space Heat and Service Water Heating (9.36.4.3.)

Solar thermal systems are not required in Section 9.36. However, if they are installed, the systems must comply with the following requirements:

1. installed in accordance with manufacturers requirements and procedures,
2. installed in accordance with other plumbing systems requirements of the Code, and
3. the storage tank must be installed in conditioned space.

Service Water Heating Piping (9.36.4.4.)

Pipe insulation is required for the first 2 m (6.5 ft) of the storage tank inlet and outlet (**Figure 7**). The insulation must be at least 12 mm (0.5") thick. In cases where piping is located outside the building enclosure or within unconditioned space, the insulation must be installed to a thermal resistance not less than the effective resistance requirements of the exterior above grade wall. In homes with recirculating hot water systems, all piping must be insulated.

Service Water Heating Controls (9.36.4.5.)

Service water heating systems are required to be equipped with controls to permit adjustment of the temperature settings.

⁴ The Homeowner Protection Office is preparing a publication on heat recovery ventilators that will be available in 2014.

Table 3: Summary of HVAC Performance Requirements

Equipment Type	Size	Performance Requirement
Space Heating Equipment		
Gas Fired Furnace	Less than 220,000 BTU/Hr (66 kW)	Annual Fuel Use Efficiency (AFUE) must be greater than or equal to 92%
Gas Fired Boiler	Less than or equal to 300,000 BTU/Hr (88 kW)	Annual Fuel Use Efficiency (AFUE) must be greater than or equal to 90%
Air Cooled Unitary Air Conditioner and Heat Pump Split System	Less than or equal to 65,000 BTU/Hr (19 kW)	Seasonal Energy Efficiency Rating (SEER) of 14.5 and Energy Efficiency Rating (EER) of 11.5
Gas Fired Tankless	Less than or equal to 250,000 BTU/Hr (73.2 kW)	Energy Factor (EF) must be greater than or equal to 0.8
Service Water Heating Equipment		
Electric Storage	13-71 Gal (50 to 270 L)	Standby loss less than or equal to 25+ 0.20V (top inlet) 40+0.20V (bottom inlet) Where V= the tank volume (in Litres)
Gas Fired Storage	Less than 75,000 BTU/Hr (22 kW)	Energy Factor (EF) must be greater than or equal to 0.67-0.0005V Where V= the tank volume (in Litres)
Gas Fired Tankless	Less than or equal to 250,000 BTU/Hr (73.2 kW)	Energy Factor must be greater than or equal to 0.8

Appendix 1: Section 9.36. Checklist

This checklist has been developed to assist builders and industry stakeholders to review the requirements of Section 9.36. of the British Columbia Building Code.

General Information

Building Address	
City	
Climate Zone (4 to 8)	
Contractor Name	
Contractor Phone Number	

Building Envelope

	Required Effective Insulation R-value	Actual Effective Insulation R-value
Wall		
Ceiling		
Basement Walls		
Basement Floors		
Window		

Specific Requirements

- Effective insulation of ceilings, walls and floors meet the requirements of Table 9.36.2.6.A and Table 9.36.2.6.B for the correct climate zone.
- The thermal characteristics of windows, door and skylights meet the requirements of Table 9.36.2.7.A, B and C for the correct climate zone.
- Effective insulation of foundations meet the requirements of Table 9.36.2.8.A or B for the correct climate zone.
- Ducts located outside the thermal enclosure are sealed and insulated to the exterior wall insulation requirements.
- Dampers are installed at air inlets and exhausts where required.
- Piping for heating or cooling systems is located within the thermal enclosure or are fully insulated.
- HVAC equipment is located within thermal enclosure or designated to be installed outside of thermal enclosure.
- Temperature controls are installed on heating and cooling equipment.
- Indoor pools are covered or have an HRV/dehumidifier.
- HVAC and SWH equipment meet minimum performance requirements determined in Tables 9.36.3.10. and 9.36.4.2.
- Service water heating pipes are insulated at the inlet and outlet of storage tanks.
- Service water heaters have temperature controls.
- The air barrier details, materials and locations have been identified.

Insulation /Air Seal Detail	Insulation Continuity	Air Barrier Continuity
1. Interior pony wall at a basement		
2. Rim joist		
3. Interior wall penetrating an exterior wall		
4. Insulated floor above garage		
5. Electrical penetration		
6. Electric panel set into an exterior wall		
7. Duct penetrating at a wall		
8. Wall behind shower/tub		
9. Wall behind fireplace		
10. Staircase walls		
11. Plumbing stack in an exterior wall		
12. Wall adjoining porch roof		
13. Door frame connection to a wall		
14. Attic knee walls		
15. Skylight shaft walls		
16. Attic access panel/stair		
17. Dropped ceiling/soffit		
18. Recessed lighting fixtures		
19. Cantilevered/floors over unheated spaces		
20. Steel/masonry chimney penetrating an attic		
21. Part wall at an exterior wall and attic		
22. Plumbing stack at an attic penetration		
23. Tapered insulation at the attic edge		
24. Slab-edge insulation		
25. Large beam set into a wall		
26. Attic/garage framing running alongside an exterior insulated wall		
27. Window and door and skylight rough opening		
28. Concrete in ICF penetrations		
29. Joints in air barrier		

HPO Technical Research
& Education
1701 - 4555 Kingsway
Burnaby, BC V5H 4V8

Phone: 778 452 6454
Toll-free: 1 866 465 6873
www.hpo.bc.ca
www.bchousing.org

